

WILLOW™ | ECO
SERIES

ESPRESSO MACHINE USER'S MANUAL

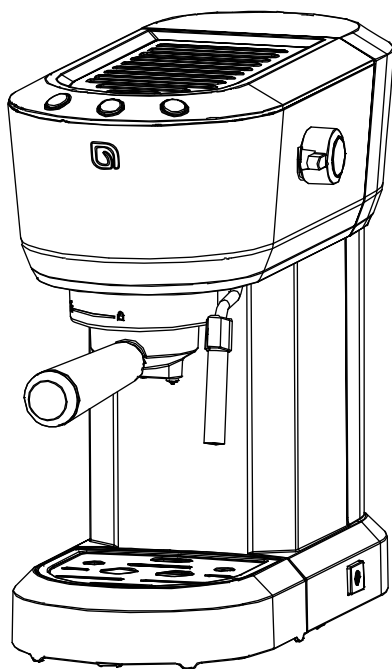

Before first use, always double-check to ensure that all packaging materials have been removed from your appliance.



DON'T BE ALARMED. New parts might have a smell when first heated, but it will fade after a few uses. This is completely normal.



Read the instruction manual before using the machine.
Save these instructions.

CONTENT

IMPORTANT SAFEGUARDS	1
POWER SUPPLY	2
HOW TO USE	3
DESCRIPTION OF PARTS	3
BEFORE FIRST USE	3
OPERATING INSTRUCTIONS	4
CLEANING AND MAINTENANCE	6
DESCALING	6
QUICK START	7
DISPOSAL	7
PRODUCT SPECIFICATIONS	8

IMPORTANT SAFEGUARDS

READ ALL INSTRUCTIONS CAREFULLY BEFORE USE. WHEN USING ELECTRICAL APPLIANCES, BASIC SAFETY PRECAUTIONS SHOULD ALWAYS BE FOLLOWED INCLUDING THE FOLLOWING:

- Before use, check that the voltage of the socket voltage corresponds to the parameters on the coffee machine's rating label.
- If the machine has grounding protection, ensure that there is a grounded socket.
- Keep children away from the machine while it is in use.
- To prevent fire and electric shock, do not immerse power cord or plug in water or any other liquid. Avoid damaging, excessively bending or stretching the power cord, and do not place heavy objects on the power cord.
- When cleaning or when not in use, please unplug the machine first, and allow it to cool down before cleaning the accessories.
- Do not use the device in high temperature, high magnetic field, or humid environments. Avoid placing the coffee machine on a hot surface, near a fire source, or on other electrical appliances, such as a refrigerator.
- Do not turn on the machine if the wire or plug is damaged, or if the coffee machine is faulty or damaged in any way, and return it to the nearest authorized service center for inspection and repair, or contact the dealer.
- Please only use original accessories.
- This machine is only designed for making coffee, do not use it for other purposes, and keep it in a dry environment.
- Place the coffee machine on a flat surface or table, and do not hang the power cord over the edge of the table or counter.
- Ensure the power cord does not touch hot surfaces.
- When the coffee machine is in operation, do not touch the hot parts with your hands.
- Clean and maintain the coffee machine regularly to ensure the quality of the coffee and extend its service life.
- When the coffee machine is working, do not move or turn off the power.
- Operating the machine without water is prohibited.
- To ensure safety, please read the instructions carefully for details and master the correct usage.
- Do not immerse the coffee machine or power cord in water or other liquids to clean.

- Do not use outdoors.
- Before using for the first time, boil water twice in it to remove odors.
- For home use only, do not use for other purposes.
- Please save the instruction booklet for future reference.

POWER SUPPLY

- Before first use, make sure the voltage matches the information on the appliance rating label.
- For safety, only connect the appliance to an outlet with a grounded feature.
- To avoid overheating, fully unwind the power cord.
- Do not let the power cord hang over the edge of tables or countertops.
- Use a short power cord and organize it to minimize the risk of entanglement or tripping. Avoid replacing it with a longer cord or using an extension cord. If needed, consult a qualified electrician to install a grounded wall socket near the appliance. Additionally, arrange the power cord to prevent accidental catching, tripping, or stepping on it.
- Do not cover the power cord or place it under a heavy object.
- Make sure the power cord is not crushed or bent especially where the power cord attaches to the appliance and the plug.
- Always unplug the power cord when the appliance is not being used, when it's malfunctioning, before attaching accessories, and before cleaning or storing it.
- Always disconnect by grasping the plug, not the cord.
- Avoid plugging in the power cord or using the appliance with wet hands or while standing in water.
- Keep the appliance and power cord away from open flames and hot surfaces
- This appliance has a polarized plug (one blade is wider than the other). To reduce the risk of an electric shock, this plug is intended to fit into a polarized outlet in one orientation only. If the plug does not fit fully into the outlet, reverse the plug. If it still does not fit, contact a qualified electrician. Do not attempt to modify the plug in any way.

KEEP THESE INSTRUCTIONS FOR FUTURE REFERENCE HOUSEHOLD USE ONLY

HOW TO USE

DESCRIPTION OF PARTS

- | | |
|-------------------------------|---------------------|
| 1. Water Tank Lid | 10. Drip tray |
| 2. Water Tank (1.2L capacity) | 11. Drip tray cover |
| 3. Steam Dial | 12. Portafilter |
| 4. Steam Wand Insulator | 13. Control buttons |
| 5. Steam Wand | 14. Cup warmer |
| 6. Power button | |
| 7. Tamper | |
| 8. 2 shots metal filter | |
| 9. 1 shot metal filter | |

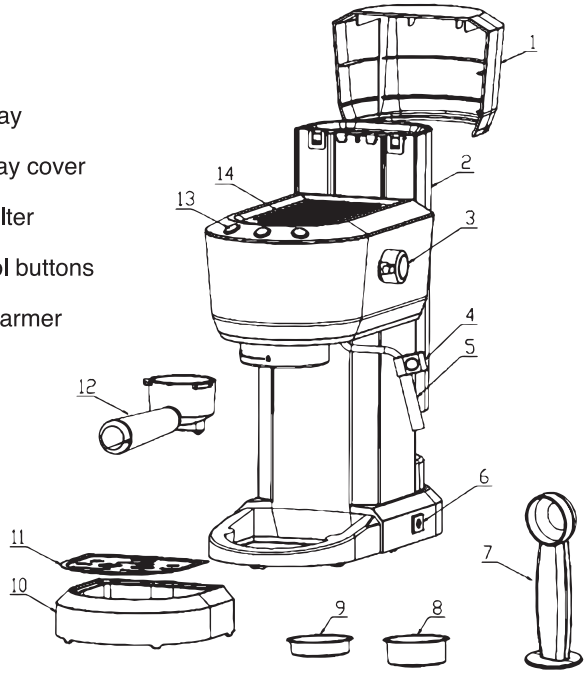

DESCRIPTION OF BUTTONS

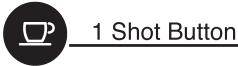

1 Shot Button



2 Shot Button







Steam Button



BEFORE FIRST USE

- Place the machine on a level, heat-resistant surface.
- Pour water into the water tank (or) remove the water tank from the machine and fill it with water. The water level should not exceed the "MAX" mark on the tank.

Note that when removing and inserting the water tank, keep it vertical up and down. When inserting it, gently press down the water tank to ensure that the valve at the base of the water tank aligns with the water valve seat on the shell.

- Take the Portafilter out and align the handle to the position marked  on the machine. Then turn the Portafilter so the handle is aligned with the position marked .
- Place a larger capacity container under the Portafilter and Steam Wand.
- Plug in the power supply, then turn on the machine. When the machine beeps, and the front buttons   light up and blink intermittently, the machine is in heating state.

Note: Make sure the steam knob is in the **OFF** position. If it is not, the machine will beep five times in a row to remind you. At this time, turn the steam knob clockwise back to the **OFF** position.

- When preheating is completed, the button  will light up solid, and then the espresso selection button function will be activated.
- Press either button   to select your coffee size, and the water pump will start working.

CLEANING THE MACHINE

When using the machine for the first time, or if it has not been used for a long time, run two more cups of water through the machine to clean it (attach portafilter to the machine and clean it together).

- Press the  double cup button. Let the water pass through the electromagnetic pump to clean the internal pipes of the machine.
- Pour out the water collected in the cup.
- Repeat this several times.

OPERATING INSTRUCTIONS

BREWING ESPRESSO

While the machine is preheating, you can put the ground coffee (not too coarse or too fine) into the "1 or 2 shot metal filter". Then use the tamper to flatten and compact it (as shown in the figure below). At the same time, wipe the excess coffee from the edge of the filter.

NOTE: If you make 1 shot of coffee, use the 1 shot filter with 7 grams of coffee. If you make 2 shots of coffee, use the 2 shots filter and put in 14 grams of coffee.

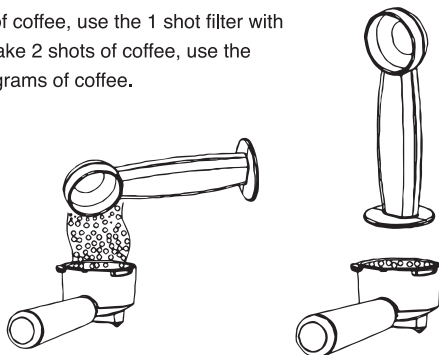

Insert the filter into the portafilter and lock it into place according to the indicator mark as shown in the figure below. Then place the espresso cup under the portafilter.

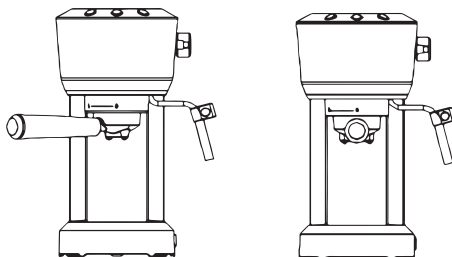

When the ☐☐ buttons are lit up solid, press either ☐☐ espresso button, and the espresso will start to flow out. (Press the ☐☐ button to flow out 1 shot of espresso, and press the ☐☐ button to flow out 2 shots of espresso)

At the same time, adjust the position of the espresso shot so that the coffee liquid flows into the shot along the inner wall.

Wait for the coffee to finish dripping before removing the espresso shot

STEAM FUNCTION

- Plug in the power supply, then turn on the machine. When the machine beeps, and the front buttons ☐☐ light up and blink intermittently, the machine is in heating state.
- When preheating is completed, the button ☐☐ will light up solid, and then the espresso selection button function will be activated. Press the ☐☐ button, and it will start to flash. The machine will be ready when the ☐☐ button lights up solid.
- Pour chilled milk into the pitcher (3.5 oz. for Cappuccino, 6 oz. for Latte), insert the steam nozzle about 1/2 inch from the surface of the milk. Turn the "steam dial" counterclockwise (As shown in the figure below) until steam starts to spray out.

Note: Release a little water in the steam pipe before frothing the milk.

Note: Suggest use skim or 2% milk at refrigerator temperature (about 41F/5°C)

Note: You should not discharge steam for more than 3 minutes at a time.

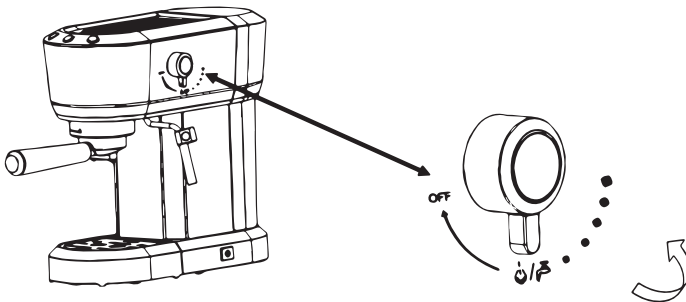



- When the milk temperature reaches about 65°C-70°C and the milk foam begins to expand, turn the "steam knob" clockwise to the **OFF** position, and press the ☐☐ button to turn off the steam function.

DELIVERING HOT WATER

- Plug in the power supply, then turn on the machine. When the machine beeps, and the front buttons ☐☐ light up and blink intermittently, the machine is in heating state.
- When preheating is completed, the button ☐☐ will light up solid. Place a cup under the steam wand and turn the steam dial counterclockwise to the ☐☐ position until hot water starts to spray out the wand continuously. Turn the steam dial clockwise to the **OFF** position to stop discharging hot water.

AUTO SHUTOFF FUNCTION

If there is no operation for 25 minutes, the machine will automatically enter the shutdown state. If you want to restart the machine, you can press any one of the   or  buttons.

CARE AND MAINTENANCE

Turn off the power supply and let the coffee machine cool down completely before cleaning.

Wipe the exterior and some accessories of the coffee machine with a damp cloth or cleaning sponge.



Grasp the middle of the water tank and lift it up to remove it;



The water tank should be cleaned once a week. Use mild detergent to clean the water tank, rinse thoroughly and wipe dry.





NOTE: The water tank cannot be put into the dishwasher.

NOTE: Do not use alcohol or solvent cleaners to clean, and do not immerse the machine in water to clean.

DESCALING

- The espresso machine counts one for each coffee brewed or steamed (including hot water extraction). When the cumulative number reaches 300, the indicator lights of the buttons  and  will flash slowly in sequence until descaling is completed.

Note: When the descaling has not been performed, (which does not affect the use of the machine) the lights  and  will continue to flash slowly in sequence to remind you.

- First put the descaling agent (about 10g) into the water tank, and then add water to the "max" line of the water tank.
- Turn on the machine and wait for the machine to preheat successfully. Put a large cup under the portafilter and press the  button. Hot water will start to flow out (**repeat this step 5 times**).
- Press and hold the  and  buttons for 3 seconds at the same time. Put a large cup under the steam wand and rotate the "steam dial" counterclockwise until hot water starts to spray out. The clean water containing the descaling agent that flows through the entire pipes of the machine. The water pump starts working, pumping water for 6 seconds and stopping for 10 seconds. This will continue for 18 cycles. When descaling is complete, the lights will blink three times in three consecutive sets, and the machine will shut down. (At this time, the count will reset to 0, and this cycle is repeated).
- Replace the water in the water tank. Press the  button and the water pump will start working. The clean water will flow through the pipes cleaning the machine. Repeated this process 5 times and the descaling is complete.

QUICK START

BREWING ESPRESSO

- Plug in and press on. Wait for the machine to beep and buttons to blink.

Note: For 1 shot: Use 7 grams in the 1 shot filter.

Note: For 2 shots: Use 14 grams in the 2 shots filter.

- Compact the coffee with the tamper until coffee grounds are even.
- Lock the portafilter into the group head and place your cup underneath.
- Wait for solid lights, then press the espresso button for 1 or 2 shots.

FROTHING MILK

- After preheating, fill a pitcher with chilled milk (3.5 oz for Cappuccino, 6 oz for Latte).
- Press the milk froth icon button and insert the steam nozzle into your pitcher, turn the steam dial counterclockwise to start.

DISPENSING HOT WATER

- Place a cup under the steam wand and turn the steam dial counterclockwise until hot water flows.

ADDITIONAL TIPS

- Auto Shutoff: Machine shuts off after 25 minutes of inactivity.
- Clean: Knock out used grounds and rinse parts after use.

DISPOSAL

Correct Disposal of this product	
	This symbol indicates that this appliance may not be treated as household waste. Instead, it should be taken to the appropriate collection point for recycling electrical and electronic equipment. Please use the return or collections services available in your community or contact the retailer where you purchased this product.

PRODUCT SPECIFICATIONS

Name	Espresso Machine
Model No.	7735MY, 7736MY, 7737MY
Rated Voltage	120 VAC, 60 Hz
Rated power	1350W
Pressure	15Bar

For customer service contact us here:



<https://www.cookwithwillow.com>



40 Wall St, Suite 1605, 16th Floor,
New York, NY 10005



support@cookwithwillow.com



1 (888) 992-5943

