

5 QUART AIR FRYER USER'S MANUAL

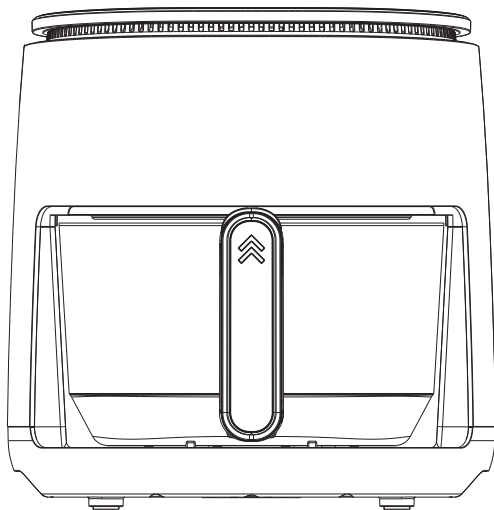

Before first use, always double-check to ensure that all packaging materials have been removed from your appliance.



DON'T BE ALARMED. New parts might have a smell when first heated, but it will fade after a few uses. This is completely normal.



Read the instruction manual before using the machine.
Save these instructions.

CONTENT

IMPORTANT SAFEGUARDS	1
POWER SUPPLY	3
HOW TO USE	4
BEFORE FIRST USE	4
DISPLAY DIAGRAM	5
OPERATING INSTRUCTIONS	5
CLEANING AND MAINTENANCE	8
DISPOSAL	9
PRODUCT SPECIFICATIONS	10

IMPORTANT SAFEGUARDS

Read all instructions carefully before use. When using electrical appliances, basic safety precautions should always be followed, including the following:

WARNING

- Before connecting the air fryer to the main supply, check that the voltage indicated on the appliance matches the mains voltage in your home. If this is not the case, do not use the air fryer.
- **DO NOT** let the power cord hang over the edge of the table or counter.
- **DO NOT** place the air fryer on or near a hot gas or electric burner, or near hot surfaces.
- Ensure that the air fryer is used on a stable flat surface, this will prevent the air fryer from overturning and avoid damage or injury.
- **THIS IS NOT A TOY. Suitable for use for children 8 years and above. Children should be supervised to ensure that they do not play with the appliance. Keep the appliance and its cord out of reach of children.** This appliance is not intended for use by individuals (including children) with reduced physical, sensory, or mental capabilities, or those lacking experience and knowledge, unless they have received supervision or instruction on the appliance's usage from a person responsible for their safety.
- Close supervision is necessary when the air fryer is used by or near children.
- Cleaning and user maintenance tasks should only be undertaken by adults.
- To prevent fire, electric shock, or personal injury, avoid immersing the air fryer cord, plug, or housing in water or other liquids.
- Avoid touching hot surfaces; instead, use the handles or knobs.
- **USE CAUTION** when turning the basket over after cooking, as the hot plate may fall out and create a safety hazard.
- **DO NOT** block any ventilation openings. Hot steam is released through openings. Keep your hands and face clear of openings.
- The air fryer is for household use only, not designed for commercial use. Do not use outdoors.
- The use of accessories, which are not recommended by the appliance manufacturer, may result in fire, electric shock, or personal injury.
- **IMPORTANT:** Unplug the air fryer from mains power outlet when not in use and before cleaning.
- Allow the air fryer to cool thoroughly before putting on or taking off parts, and before cleaning the appliance.
- To disconnect the air fryer, switch "**OFF**" the power switch on the air fryer first, then remove the plug from the mains power outlet.
- If the supply cord is damaged, it must be replaced by a qualified electrician in order to avoid a hazard or the product must be disposed of.
- **DO NOT** use the appliance for other than intended use.

WARNING (continued)

- This appliance must not be immersed in water or other liquids.
- Avoid liquid spillage on the electrical connectors.
- **The air fryer is subject to residual heat after use. Misuse may cause injury or property damage.**
- **DO NOT** operate the air fryer on an inclined plane or move while the air fryer is switched on.
- **BE EXTREMELY CAUTIOUS** when moving your air fryer (or removing the basket) if it contains hot oil or other hot liquids.
- **CAUTION:** To prevent damage to the appliance, do not use alkaline cleaning agents when cleaning. Use a soft cloth and mild detergent.
- **DO NOT** strike or hit the top of the air fryer with hard objects, as this may cause the tempered glass to crack. Tempered glass is stronger and fractures more safely than ordinary glass, but it may shatter unexpectedly after being cracked.
- Regularly inspect the power cord for any signs of damage or wear, and replace if necessary.
- **DO NOT** attempt to repair or disassemble the air fryer yourself. Contact a qualified technician for servicing.
- Avoid operating the air fryer near flammable materials or in areas where flammable vapors may be present.
- **DO NOT** use the air fryer if it has been dropped, damaged, or if there are any visible signs of malfunction.
- **DO NOT** leave the air fryer unattended while it is in use.
- Allow the air fryer to cool completely before storing it or attempting to clean it.
- Avoid placing the air fryer near edges or in locations where it could be easily knocked over.
- Always place the air fryer on a heat-resistant surface to prevent damage to countertops or tables.
- **DO NOT** use the air fryer if the power cord or plug is damaged; contact the manufacturer for a replacement.
- Before storing the air fryer, ensure it is completely dry to prevent mold or mildew growth.
- **DO NOT** use abrasive cleaners or scouring pads on the air fryer's exterior surface.
- **DO NOT** rinse the glass basket with cold water immediately after use.
- Keep the air fryer away from sources of direct sunlight or heat when not in use.
- In the event of any unusual noises, smells, or smoke coming from the air fryer, immediately unplug and discontinue use.

POWER SUPPLY GUIDELINES

- Before using the appliance, ensure the power voltage matches the information on the appliance rating label.
- Only connect the appliance to a grounded outlet for safety.
- Fully unwind the power cord to avoid overheating.
- Do not let the power cord hang over the edge of tables or countertops.

IMPORTANT POWER SUPPLY SAFEGUARDS

- Use a short power cord and organize it to minimize the risk of entanglement or tripping. Avoid using an extension cord. Consult a qualified electrician if needed.
- Avoid covering or placing heavy objects on the power cord.
- Ensure the power cord is not crushed or bent, especially at the appliance and plug connections.
- Always unplug the appliance when not in use, before attaching accessories, and before cleaning or storing it.
- When disconnecting, grasp the plug, not the wire.
- Avoid using the appliance with wet hands or while standing in water.
- Keep the appliance and power cord away from open flames and hot surfaces.
- **NOTE:** This appliance has a polarized plug (one blade is wider than the other). Ensure it fits into the outlet correctly. To reduce the risk of electric shock, it is intended to fit into a polarized outlet only one way. If the plug does not fit fully into the outlet, reverse the plug. If it still does not fit, consult a qualified electrician. Do not modify the plug in any way.

KEEP THESE INSTRUCTIONS FOR FUTURE REFERENCE

FOR HOUSEHOLD USE ONLY

HOW TO USE

DESCRIPTION OF PARTS

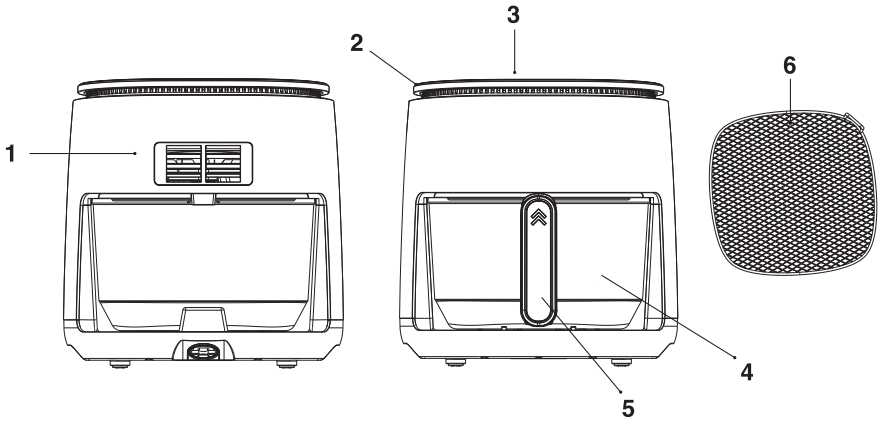

1. Air Outlet

2. Air Inlet

3. Control Screen

4. Basket

5. Basket Handle

6. Plate

BEFORE FIRST USE

Check that all accessories are complete, and the unit is not damaged. Remove all packaging from the air fryer, including any temporary stickers. Place the air fryer on a stable, level, heat-resistant surface. Keep away from areas that can be damaged by steam (such as walls or cupboards).

Note: Leave 5 inches/13 cm of space behind and above the air fryer. Leave enough room in front of the air fryer to remove the basket. Remove all plastic from the basket.



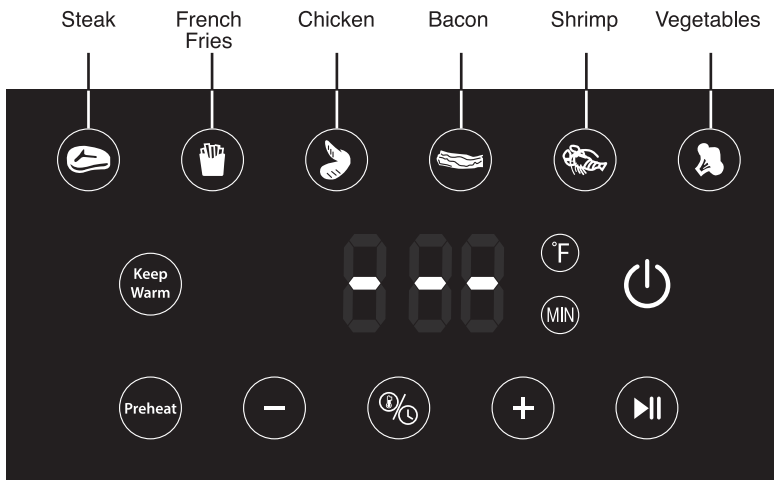

Before first use, wash both the basket and plate thoroughly, using either a dishwasher or a non-abrasive sponge. Wipe the inside and outside of the air fryer with a slightly moist cloth. Dry with a towel. Insert the plate back into the basket, and place the basket inside the air fryer.

DISPLAY DIAGRAM



OPERATIONS

Function Button definitions:

Icon	Function	Functional Attributes
 	Temperature and Time Adjustment	<p>When the time or temperature buttons can be selected, press the plus/minus keys to adjust the temperature or time.</p> <p>Time Adjustment: Single press to adjust + or - by 1minute. Long press to adjust quickly + or - by 1 minute.</p> <p>Temperature Adjustment: Single press to adjust + or - by 10°F. Long press to adjust quickly + or - by 10°F.</p>
	Temperature and Time Adjustment	<p>In the function setting stage, press the temperature/time switch button to switch the setting content</p>
	Power ON/OFF	<p>When the Air Fryer is plugged in a tone will sound and the control panel will light up for 3 seconds. After 3 seconds the power button light will stay on.</p> <p>When the power button is pressed a tone will sound and all the buttons will light up. The buttons will remain active for 20 seconds.</p> <p>To STOP any operation press the power button. NOTE: The fan will remain on for 3 minutes.</p>

OPERATIONS

START FUNCTION

In standby mode, select the desired function, touch the button icon, the button will flash and the digital tube will display the corresponding default time. Enter the menu selection. Enter the time adjustment. At this time, press the plus/minus key (⊕/⊖) to adjust the time. Press once. Press the temperature/time (⊙) button to enter temperature adjustment. At this time, press the plus/minus button (⊕/⊖) to adjust the temperature. After confirming, press the start/pause (⏸) button to start working. At this time, the corresponding function button stops flashing and the function light is always on. Other buttons are off and cannot be selected (except Temperature, time, start-pause power switch button).

During the working process, time and temperature are displayed alternately every five seconds (when the time is displayed, the time light (⊙) is on and the temperature light is off; when the temperature (⊙) is displayed, the temperature light is on and the time light is off). Once the countdown concludes, the display will show "End." It will flash and emit a buzzer sound three times, once per second. After three seconds, both the Power On/Off (⏻) button and the "End" message on the display will remain on.

During the working process, press the start-pause button (⏸) at any time, all functions will stop working, the start-pause button will flash, and the digital tube time will stop counting. Press the start-pause button (⏸) again to continue working and the buttons will stop flashing, and the digital tube will continue to time.

START-PAUSE

During the working process, press the start-pause button, the buzzer will beep once, stop working and enter the pause state, the start-pause button will flash, and the digital tube time will stop counting. Press it again to continue working and the button will stop flashing, and the digital tube will continue.

BUZZER:

Simply press any button and the buzzer will make a beep sound, indicating that the button has been sensed. The button that is set to be deselected will not make a sound.

Set the work menu to confirm the start of work. A beep will sound to indicate that the work has started. After the work is completed, the alarm will beep three times to indicate that the work is completed.

During work or in other situations except standby mode, after opening/closing the door (micro switch is disconnected/connected), the buzzer will make a "beep" sound to indicate that the door is open or closed. After opening the door, it will enter the pause state. Continue to work after closing the door; If the furnace cavity temperature probe is short-circuited or open-circuited, the digital tube will display the corresponding fault code, and the buzzer will sound 10 times as an alarm.

ERROR CODE:

E1 baking sensor open circuit

E2 bake sensor short circuit

E3 Baking sensor overtemperature (this fault occurs when the temperature exceeds 250 degrees during operation)

If a fault occurs, the buzzer will sound 10 times and the corresponding fault code will be displayed to stop working. Only after the fault is eliminated can the power be restored.

OPERATIONS









FUNCTION TIME TEMPERATURE

In the work pause state, if there is no operation for 30 minutes, it will enter the shutdown state.

If a fault occurs, the buzzer will sound 10 times and the corresponding fault code will be displayed to stop working. Only after the fault is eliminated can the power be restored.

POWER-OFF MEMORY FUNCTION

Unplug the power during work and power it on again within 30 minutes. The program will automatically enter the working mode before the power outage and continue to work until the end.

Menu		Default Temperature (°F)	Adjustable Temperature Range (°F)	Default Time (min)	Adjustable Time Range (min)
Steak		330	210~430	25	1-60
French Fries		390	210~430	15	1-60
Chicken		370	210~430	20	1-60
Bacon		330	210~430	10	1-60
Shrimp		370	210~430	20	1-60
Vegetables		390	210~430	15	1-60
Preheat		310	210~430	5	1-60
Keep Warm		210	210~430	10	1-60

CLEANING AND MAINTENANCE

- Always disconnect the appliance from the power outlet and let it cool down completely before cleaning.
- Wipe the exterior of the air fryer with a soft damp cloth. Never use abrasive cleaners.
- The basket and plate are dishwasher safe. You can also wash the basket and crisper plate with hot, soapy water and a non-abrasive sponge. Soak if necessary.

For stubborn grease:

- a. In a small bowl, mix 2 US tbsp / 30 mL of baking soda and 1 US tbsp / 15 mL of water to form a spreadable paste.
 - b. Use a sponge to spread the paste on the basket and plate and scrub. Let the basket and plate sit for 15 minutes before rinsing.
 - c. Wash basket with soap and water before using.
- Clean the inside of the air fryer with a slightly moist, non-abrasive sponge or cloth. Do not immerse in water.
 - Clean the heating coil to remove food debris as needed.
 - **CAUTION:** Avoid using chemical, steel, wooden, or abrasive cleaners on the exterior of the air fryer to prevent damage to the finish.
 - When not in use or during storage, wind the power cord under the bottom of the air fryer's power base.

QUICK START

- Plug your Willow 5qt Air Fryer into an electrical outlet.
- Select the desired function on the digital touch display.
- Adjust the time and temperature according to personal preference or cooking needs.
- Press the start button to begin the air frying process.
- Once the air frying cycle is complete, you will hear a beep and the digital display will read "end"; then you can pull out the glass pot.
- Only wash the glass pot accessory in the dishwasher.
- Wipe down the external parts of your air fryer as well as the digital touch display.

DISPOSAL

Correct Disposal of this product



This marking indicates that this product should not be disposed with other household wastes throughout the EU. To prevent possible harm to the environment or human health from uncontrolled waste disposal, recycle it responsibly to promote the sustainable reuse of material resources. To return our used device, please use the return and collection systems or contact the retailer where the product was purchased. They can take this product for environmental safe recycling.

PRODUCT SPECIFICATIONS

Name	Air Fryer
Model No.	7723MY, 7724MY, 7725MY
Rated Voltage	120 VAC, 60 Hz
Rated power	1500W

For customer service contact us here:



<https://www.cookwithwillow.com>



40 Wall St, Suite 1605, 16th Floor,
New York, NY 10005



support@cookwithwillow.com



1 (888) 992-5943

